

ASTERIA UP

Designed by Soren Ravn Christensen

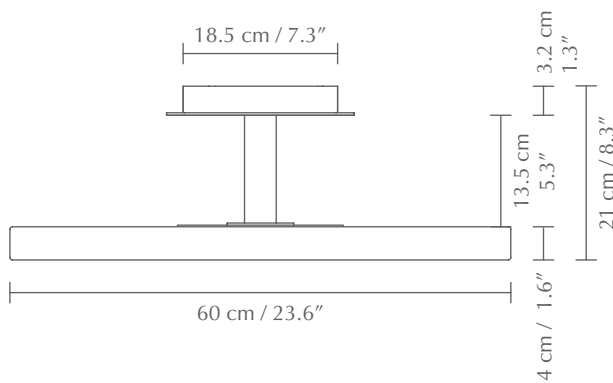

Colour variations



pearl white
(RAL: 9001)



anthracite grey
(RAL: 7016)

 Surface mounted lamp

 **CERTIFICATION**
CE (for indoor use), IP2X, UL/cUL certified

 **DIMENSIONS**
Ø: 60 cm / 23.6"
H: 21 cm / 8.3"

 **MATERIAL**
Steel and PS
Metal canopy

 **WARRANTY**
10 years warranty against manufacturer defects

 **WEIGHT INCL. PACKAGING**
8.3 kg / 18.3 lb

 **LIGHT SOURCE**
37W LED panel incl. ambient top light. 3000 K - 2300 lm
RA: >80. Dimmable with external dimmer*. 25000 H

 **PACKAGING**
Gift box dimensions (W×H×D): 81.8 x 62.2 x 7.7 cm

 **ASSEMBLY TIME**
10 min - video guide at umage.com

 **MEDIA KIT**
Photos, 3D models, 2D drawings
Download at umagepress.com

 **ORDERING INFORMATION**
Asteria Up pearl white #2329
Asteria Up anthracite grey #2330

* For recommended external dimmers, go to umagepress.com

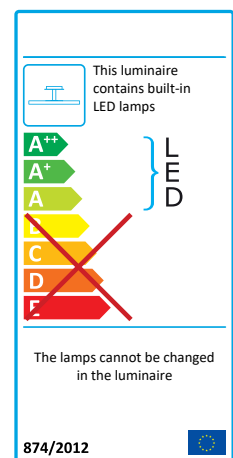

UMAGE

ASTERIA UP

Designed by Soren Ravn Christensen

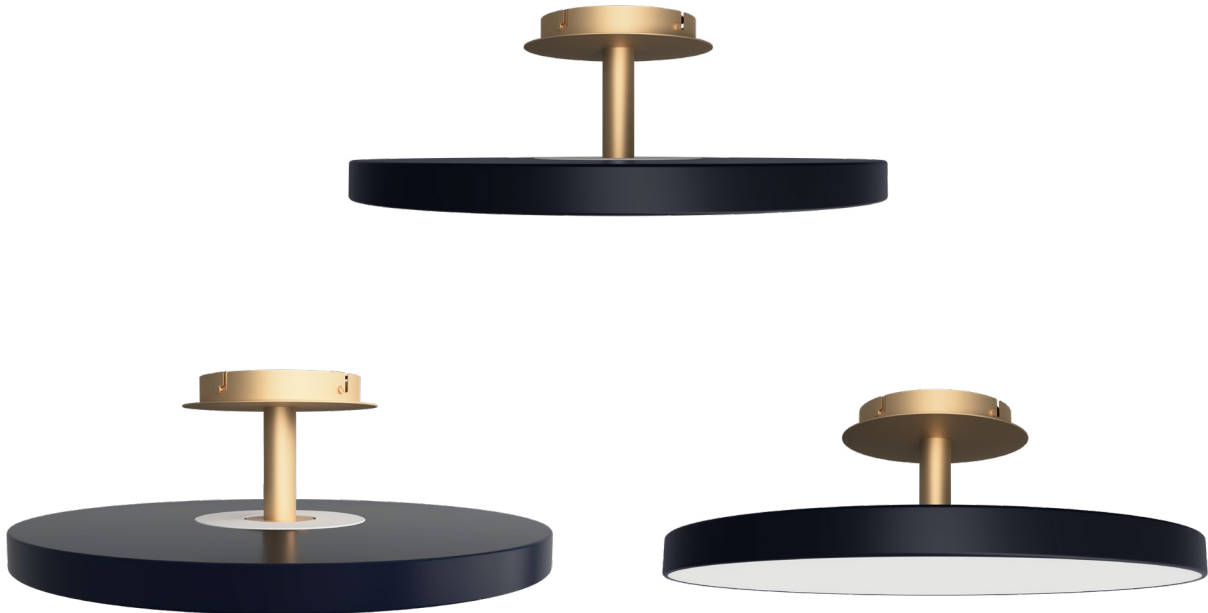

DISCRETE AND STYLISH

Finding the right light for the kitchen and hallways can be a challenge. The new Asteria Up ceiling lamp is not only offering the perfect light but is also a very discrete and stylish solution.

The lampshade is placed on a brass base, adding a refined expression to the lamp design. A top panel provides an ambient light upwards as well, enhancing the details of the design and secures a soft atmosphere in the surrounding space.

Find more info on our website umage.com

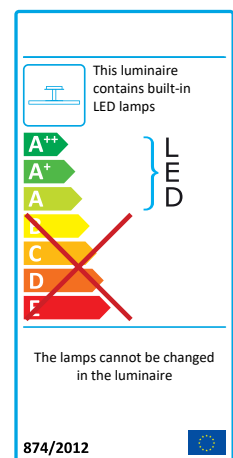

ASTERIA UP

Designed by Soren Ravn Christensen

